



# 190A STORM

weight indicator



The 190A is designed for non-legal-for-trade portable axle weighing applications

**Axle Weigher Software**

- Optional Internal Rechargeable Battery
- Traffic Control Mode Automatically Captures Weights
- (2) RS232 Serial Outputs with Time and Date

# Factoring Axle Weights

Cardinal Scale's 190A indicator makes factoring axle weights easy by simply pressing the PRINT key to accumulate each axle's weight.

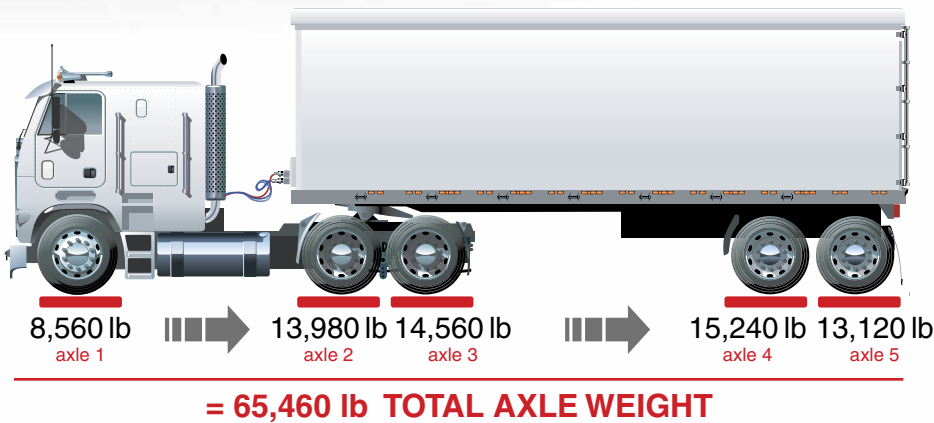

## TRAFFIC CONTROL

The 190A also features traffic control mode when used with a SB500 remote display with traffic lights and a printer. This auto mode allows the truck driver to stay in the truck throughout the axle weighing process. The indicator senses the weight and the traffic light turns green directing the driver to pull forward.

## 3 Different Versatile Power Options

- **2 RS232 Serial Ports** (for remote display and printer)
- **One ID**

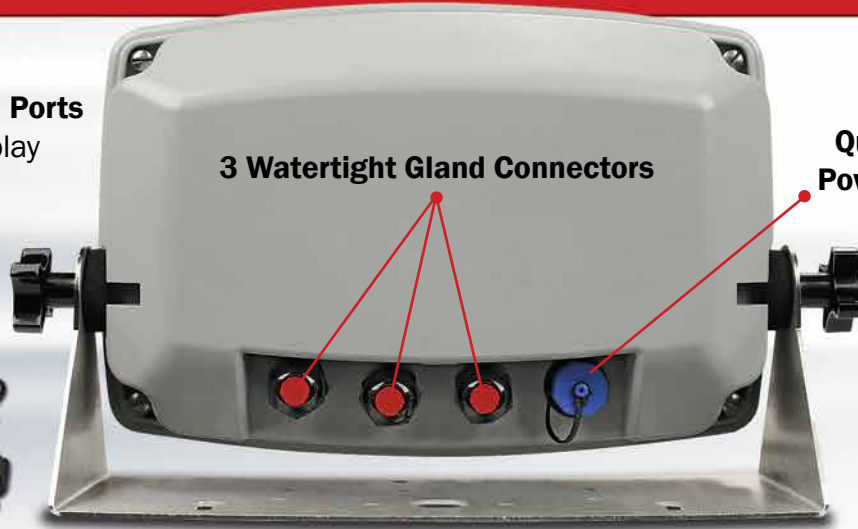

Optional **PS190** wall adapter with US, UK, EU and Australian plugs

Optional **BP190** rechargeable lithium ion internal battery pack



Optional **190DC12** car battery charger cable with 12-foot length and battery terminal eyelets (also available in 6 and 18 foot lengths)



## Efficient Axle Weighing with the 190A



Use the 190A indicator with Cardinal's **760 series** axle scales



The 190A may be used with Cardinal's **CWL40** portable axle scales



Comes complete as **CWL40-KIT**

Thermoplastic IP69K watertight enclosure offers the highest protection rating possible

1-inch/25-mm high backlit LCD visible in direct sunlight

Battery status level



Color-coded capacitive touch type keypad

Pushbutton tare function

Convenient pushbutton units switching



**COMPLETE TICKET CONFIGURABILITY**

Convenient print tab settings with X-Y coordinates make it easy to setup a ticket with the information you need to print for any ASCII printer. With Cardinal's powerful nControl software you can create additional custom print formats for truck tickets, weight receipts, and even bar coded labels to your specifications.

9:47	01-27-13
1	9740 lb
2	16320 lb
3	15980 lb
4	15880 lb
5	15700 lb
Total	73620 lb



Model P150  
Battery-operated  
Thermal Printer

**5 different LCD color modes** (or turn backlight off)

Color-changing backlit LCD display with up to 6 customizable settings

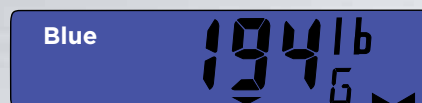
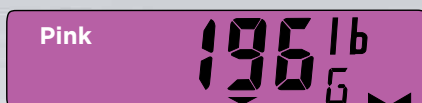
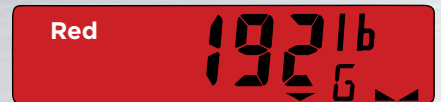
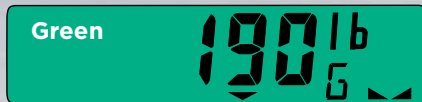
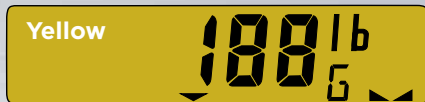

# 190A SPECIFICATIONS

<b>Power Requirements:</b>	10.5 to 30 VDC 1.0A Max.
<b>Enclosure Type:</b>	Thermoplastic IP69K wall or desk-mount
<b>Enclosure Size:</b>	9.4 inch W x 6.4 inch H x 3.7 inch D / 239 mm W x 163 mm H x 93 mm D
<b>Operating Environment:</b>	Temperature: 14 to 104 °F (-10 to +40 °C) Humidity: 90% non-condensing (maximum)
<b>Display:</b>	Six digit, seven segment, 1.0 inch / 25 mm high Backlit LCD
<b>Transducer Excitation:</b>	5.18 VDC
<b>Signal Input Range:</b>	0.5 mV min. to 40 mV max. (with dead load boost)
<b>Compatibility:</b>	Designed strictly for axle pad weighing use with Cardinal's CWL-40 and 760 series
<b>Load Cell Cable Length:</b>	1500 feet maximum. 30 feet maximum without sense lines <i>Consult factory for other requirements</i>
<b>Division Value:</b>	1, 2, or 5 x 10, 1, 0.1, 0.01, 0.001 commercial 0 to 99, non-commercial
<b>Sensitivity:</b>	NON-COMMERCIAL 0.15 uV/e COMMERCIAL 0.5uV/e (Class III/IIIL/IIHHD)
<b>Scale Divisions:</b>	NON-COMMERCIAL 100 to 240,000 COMMERCIAL 100 to 10,000 (Class III/IIIL/IIHHD)
<b>Internal Resolution:</b>	1 part in 16,777,216
<b>Tare Capacity:</b>	Scale Capacity
<b>Sample Rate:</b>	1 to 100 samples per second, selectable
<b>Auto Zero Range:</b>	0.5 or 1 through 9 divisions
<b>Weighing Units:</b>	Pounds, Ounces, Kilograms, Grams
<b>Keypad:</b>	Color Coded Capacitive Touch type, 7 keys
<b>Standard I/O:</b>	(2) bi-directional RS232 serial ports
<b>NTEP Approval:</b>	Certificate of Conformance No. 10-084

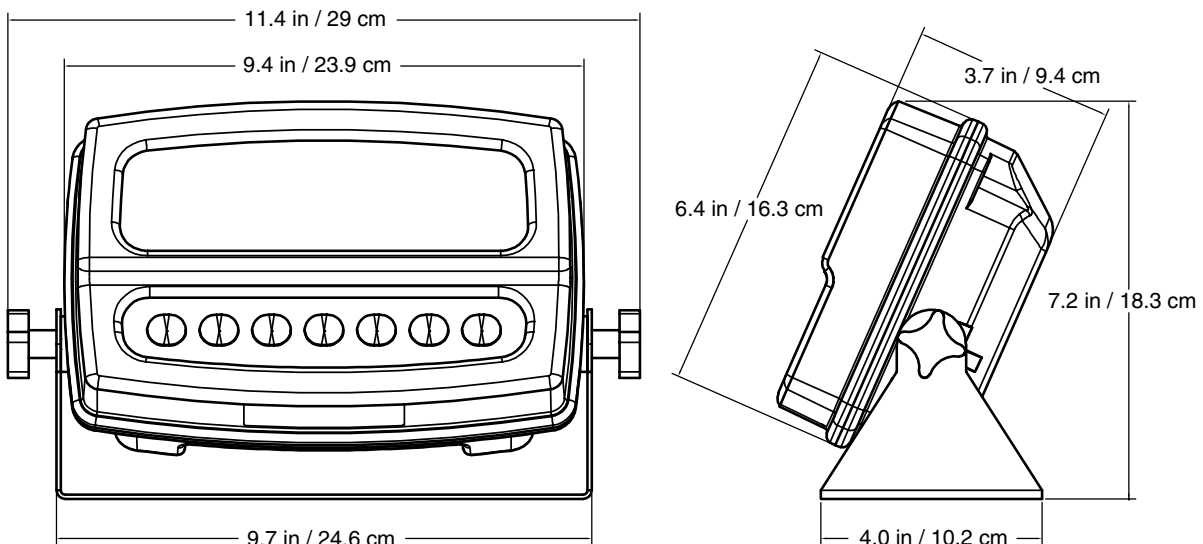

Cardinal Scale reserves the right to improve, enhance or modify features and specifications without prior notice. All registered trademarks are the property of their respective owners.

**Cardinal**  
 Cardinal Scale Manufacturing Co.  
 203 E. Daugherty, Webb City, MO 64870 USA  
 Ph: 417-673-4631 or 800-441-4237 • Fax: 417-673-5001  
[www.CardinalScale.com](http://www.CardinalScale.com)

**SOLD BY:**

